

SIP Outdoor Intercom



CyberData

The IP Endpoint Company

The SIP Outdoor Intercom delivers two-way communication and secure access control for your VoIP phone system. These devices are perfect for settings such as commercial/residential facilities, schools and universities, retail establishments, warehouse and manufacturing plants, SMB, parking garages, shipyards, and so much more.

CyberData has maintained one of the most comprehensive lists of IP PBX servers certified to work with CyberData VoIP Products.



Features

- Full duplex audio with enhanced acoustic echo cancelling
- Half duplex push to talk audio from the phone side using the phone's keypad or from the intercom side using the call button
- Simultaneous SIP and multicast
- User-uploadable ring and alert tones
- Loud/Night Ringer function - second SIP extension

- DTMF-controlled dry relay contact for auxiliary control
- Door closure and tamper alert signal
- Network volume control
- Supports Outdoor Auxiliary Strobe Kit for IP65-rated outdoor visual notification

- TLS 1.2 and SRTP enhanced security for IP endpoints in a local or cloud-based environment
- Autoprovisioning via HTTP, HTTPS, or TFTP
- HTTPS or HTTP web based configuration. HTTPS is enabled by default
- Configurable event generation for device health and status monitoring
- 802.11q VLAN tagging
- Web-based upgradeable firmware
- Support for Cisco SRST resiliency

Specifications

Ethernet I/F	10/100 Mbps
Protocol	SIP RFC 3261 Compatible
Power Input	PoE 802.3af compliant or +8 to +12VDC @ 1000mA Regulated Power Supply (not included)
Speaker Output	2 Watts Peak Power
On-Board Relay	1A @ 30 VDC
Payload Types	G.711 a-law, G.711μ-law, G.722, and G.729
Network Security	TLS/SSL 1.2 and SRTP
IP Rating	IP65
Operating Range	Temperature: -40° C to 55° C (-40° F to 131° F) Humidity: 5-95%, non-condensing
Storage Temperature	Temperature: -40° C to 70° C (-40° F to 158° F)
Storage Altitude	Up to 15,000 ft. (4573 m)
Dimensions*	5.118 inches [130 mm] Length 2.252 inches [57.21 mm] Width 5.118 inches [130 mm] Height
Weight	2.0 lbs. [0.90 kg]
Boxed Weight	3.0 lbs. [1.36 kg]
Compliance	CE; EMC Directive – Class A EN 55032 & EN 55024, LV Safety Directive – EN 60950-1, RoHS Compliant, FCC; Part 15 Class A, Industry Canada; ICES-3 Class A, IEEE 802.3 Compliant
Warranty	2 Years Limited
Part Number	011186

*Dimensions are measured from the perspective of the product being upright with the front of the product facing you.

SIP Outdoor Intercom

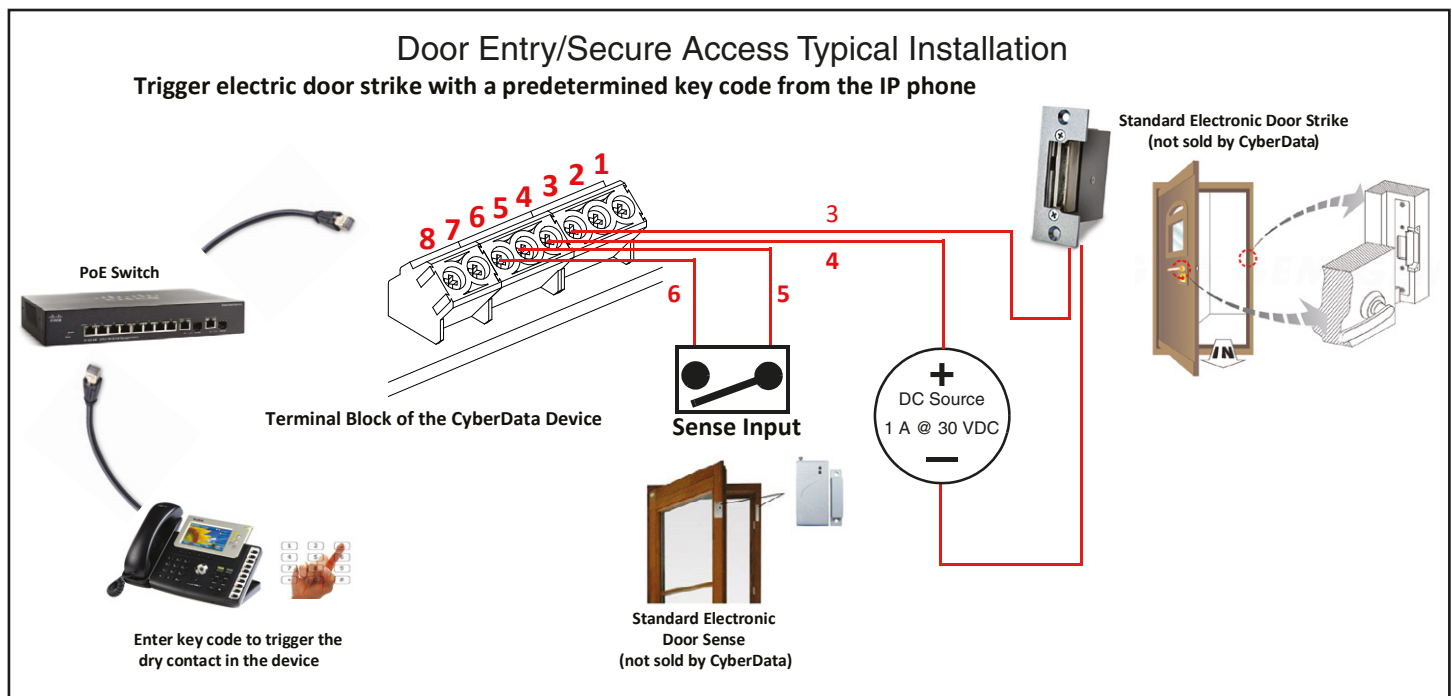
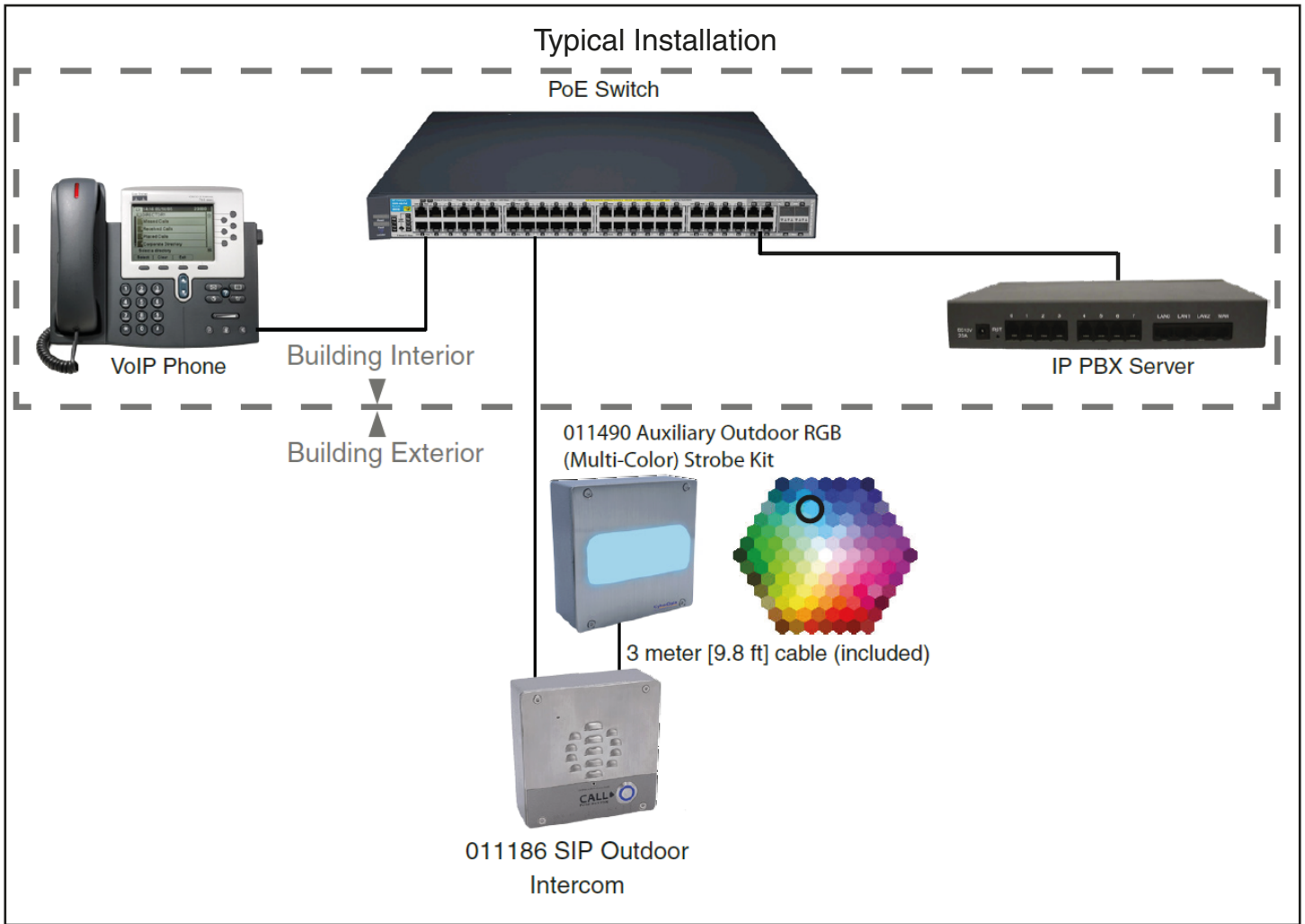

SIP Outdoor Intercom

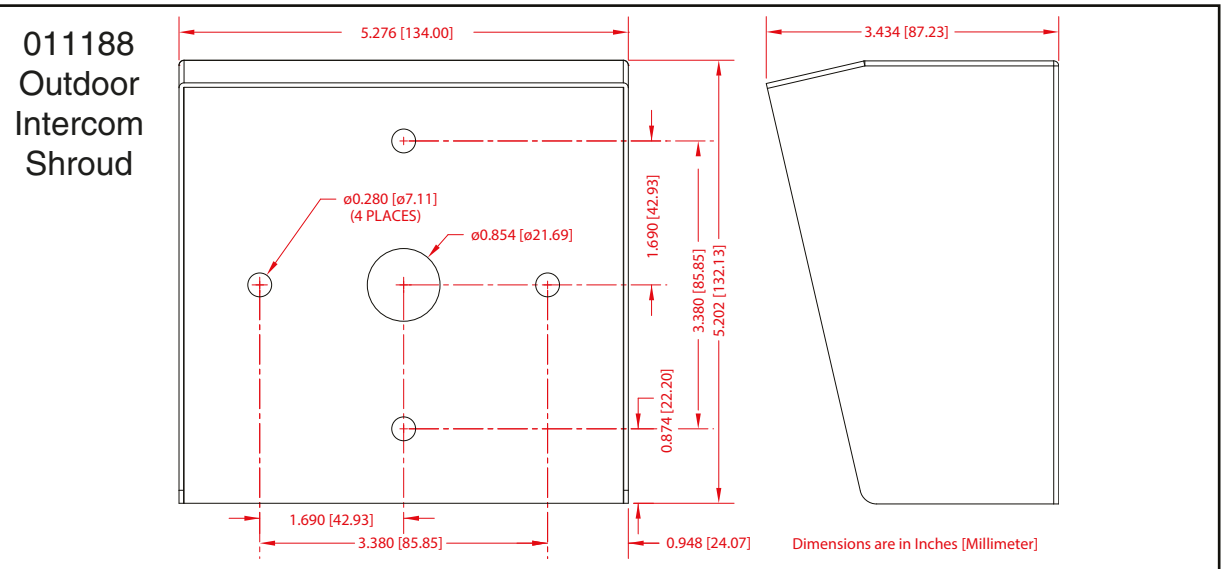
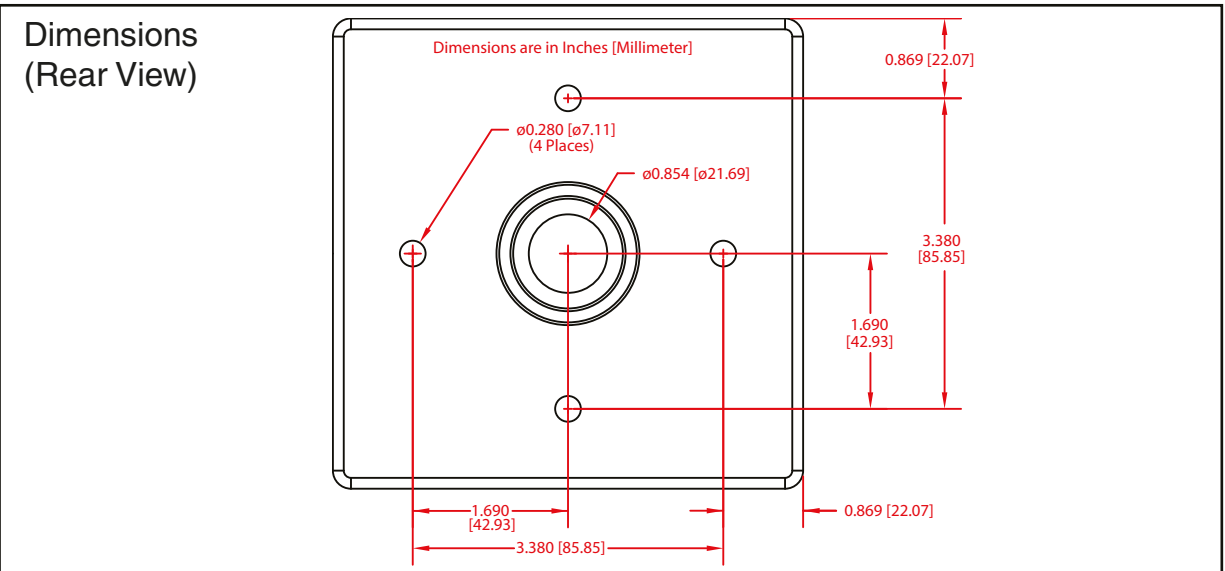
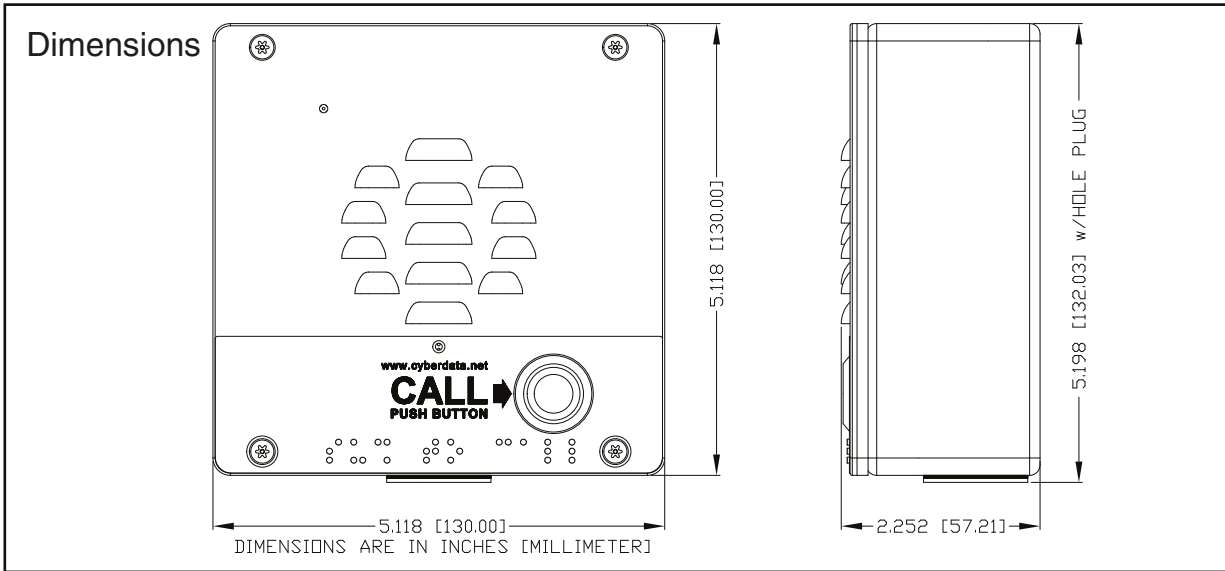

SIP Outdoor Intercom

Related Products:



011375 Network Dual
Door Strike Relay



011269 Door Strike
Intermediate Relay Module

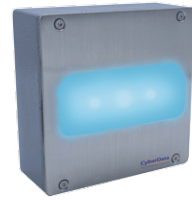

011490 Outdoor Auxiliary RGB
(Multi-Color) Strobe Kit



011188 Outdoor
Intercom Shroud

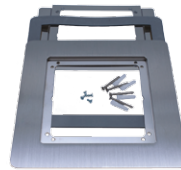

011443 Flush Mount Kit, 1X